

# Weighted Automata and Expressions over Pre-rational Monoids.

Delta Marseille

- 1 Preliminary notions
- 2 Tiles
- 3 Monoids automata and expressions
- 4 Transformations

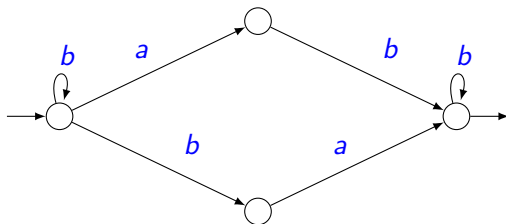

$$b^*(ab + ba)b^*$$

# Weighted expressions and automata

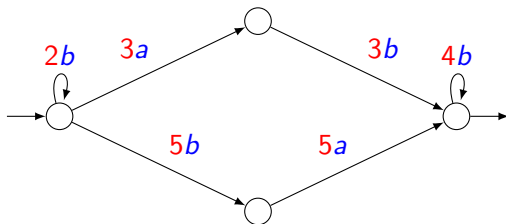

$$(2b)^*(3a3b + 5b5a)(4b)^*$$

# Weighted expressions and automata

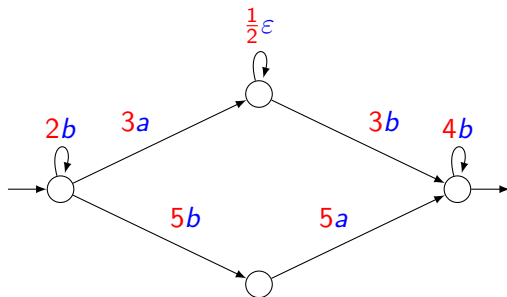

$$(2b)^*(3a(\frac{1}{2}\epsilon)^*3b + 5b5a)(4b)^*$$

# Two-way automata

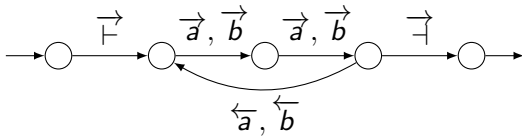

# Two-way automata

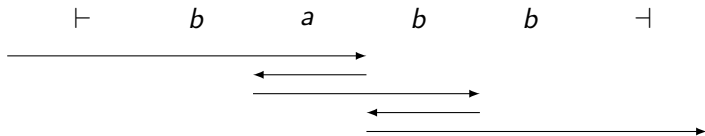
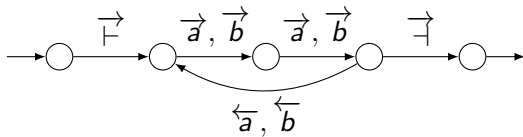

# Two-way automata

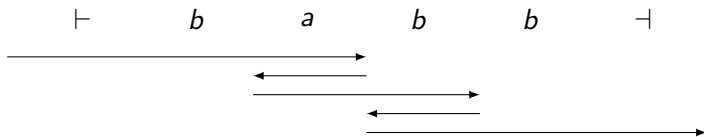
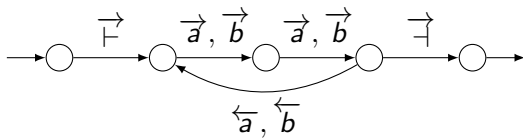

Infinite sum ?!



Axioms for  $\Sigma$  :

Axioms for  $\Sigma$  :

- $\Sigma\{a, b\} = a + b$

Axioms for  $\sum$  :

- $\sum\{a, b\} = a + b$
- $\sum_{n \in \mathbb{N}} x^n$  exists for all  $x$

Axioms for  $\sum$  :

- $\sum\{a, b\} = a + b$
- $\sum_{n \in \mathbb{N}} x^n$  exists for all  $x$
- $x \sum y_i = \sum(xy_i)$  (distributivity)

Axioms for  $\sum$  :

- $\sum\{a, b\} = a + b$
- $\sum_{n \in \mathbb{N}} x^n$  exists for all  $x$
- $x \sum y_i = \sum(xy_i)$  (distributivity)
- "associativity"

Axioms for  $\sum$  :

- $\sum\{a, b\} = a + b$
- $\sum_{n \in \mathbb{N}} x^n$  exists for all  $x$
- $x \sum y_i = \sum(xy_i)$  (distributivity)
- "associativity"

Examples :

- $(\mathbb{Q}_+ \cup \{\infty\}, +, \times)$
- Rational languages
- Tropical semirings

Not all families need to be summable.

Axioms for  $\sum$  :

- $\sum\{a, b\} = a + b$
- $\sum_{n \in \mathbb{N}} x^n$  exists for all  $x$
- $x \sum y_i = \sum(xy_i)$  (distributivity)
- "associativity"

Examples :

- $(\mathbb{Q}_+ \cup \{\infty\}, +, \times)$
- Rational languages
- Tropical semirings

Not all families need to be summable.

Co-examples :

- $\mathbb{Q}$
- $\mathbb{Z}$
- ...

Expressions for weighted  $2w$  ?



# Objectives

Expressions for weighted 2w ?

Alur Expressions

$$E, F := k \mid a \mid E + F \mid E.F \mid E^* \mid E \overleftarrow{\cdot} F \mid E \overleftarrow{*} \mid E \odot F \mid E \overleftrightarrow{\cdot} \mid E \overleftrightarrow{\cdot}$$

For non ambiguity only !

Expressions for weighted 2w ?

Alur Expressions

$$E, F := k \mid a \mid E + F \mid E.F \mid E^* \mid E \leftarrow F \mid E \overleftarrow{*} \mid E \odot F \mid E \leftrightarrow \mid E \overleftrightarrow{\phantom{a}}$$

For non ambiguity only !

But all semirings.

The sum is useless (monoid).

# The main idea

Series :  $A^* \mapsto \mathbb{K}$

# The main idea

Series :  $M \mapsto \mathbb{K}$

# The main idea

Series :  $M \mapsto \mathbb{K}$

Sakarovitch : graded monoids

$\varphi : M \mapsto \mathbb{N}$  such that:

- $\varphi(m) > 0$  if  $m \neq 1_M$
- $\varphi(mn) = \varphi(m) + \varphi(n)$

# The main idea

Series :  $M \mapsto \mathbb{K}$

## Sakarovitch : graded monoids

$\varphi : M \mapsto \mathbb{N}$  such that:

- $\varphi(m) > 0$  if  $m \neq 1_M$
- $\varphi(mn) = \varphi(m) + \varphi(n)$

## Examples

- Free Monoid
- Commutative Monoid

# The main idea

Series :  $M \mapsto \mathbb{K}$

## Sakarovitch : graded monoids

$\varphi : M \mapsto \mathbb{N}$  such that:

- $\varphi(m) > 0$  if  $m \neq 1_M$
- $\varphi(mn) = \varphi(m) + \varphi(n)$

## Examples

- Free Monoid
- Commutative Monoid

## Co-examples

- Free group
- idempotent ( $\neq 1_M$ ).

- 1 Preliminary notions
- 2 Tiles**
- 3 Monoids automata and expressions
- 4 Transformations



# Tile monoid of Dicky/Janin

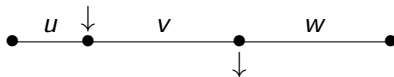

# Tile monoid of Dicky/Janin

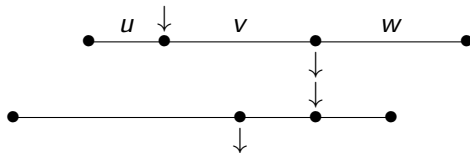

# Tile monoid of Dicky/Janin

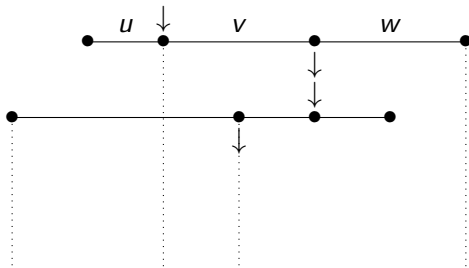

# Tile monoid of Dicky/Janin

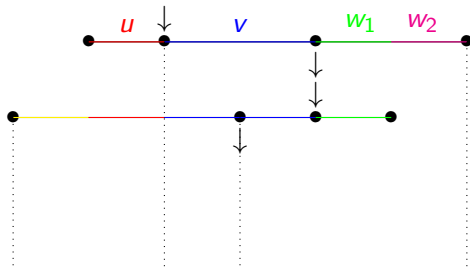

# Tile monoid of Dicky/Janin

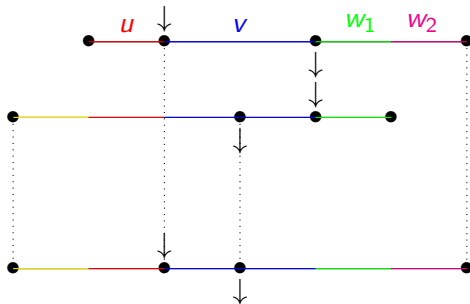

# Tile monoid of Dicky/Janin

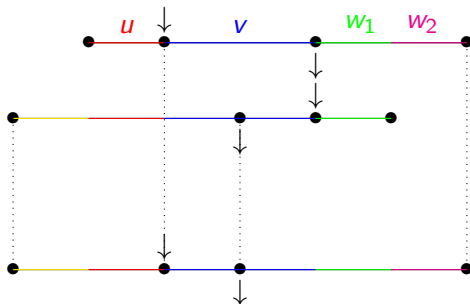

Generated by :  $\begin{array}{c} \downarrow \\ \xrightarrow{a} \\ \downarrow \end{array}$  , noted  $a$ ,  $\begin{array}{c} \xrightarrow{a} \\ \downarrow \end{array}$  , noted  $\bar{a}$

# Example

Tuile  $\vdash ab \dashv$

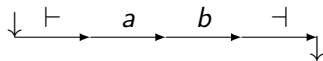

# Example

Tuile  $\vdash ab \dashv$

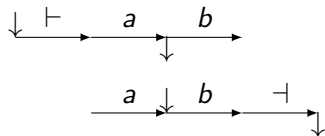
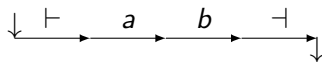

$$\vdash abb \cdot \bar{a}ab \dashv$$

$$\vdash abb \cdot b\bar{b}\bar{a}ab \dashv$$



# Example

Tuile  $\vdash ab \dashv$

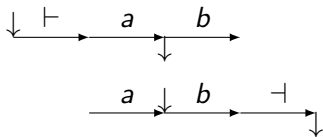
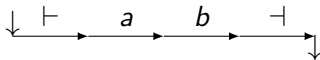

$$\vdash abb \bar{b} \cdot \bar{a}ab \dashv$$

$$\vdash abb \bar{b} \cdot b\bar{b}\bar{a}ab \dashv$$

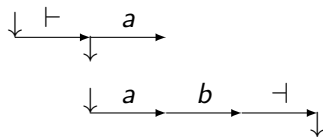

$$\vdash a\bar{a} \cdot ab \dashv \bar{\vdash} \dashv$$

$$\vdash a\bar{a}a\bar{a}a\bar{a} \cdot ab\bar{b}\bar{a}ab \dashv$$

Given a tile :

- Finite factors
- Infinitely many representatives (but a regular language)
- Captures families of 2-way runs

# Two-way automata

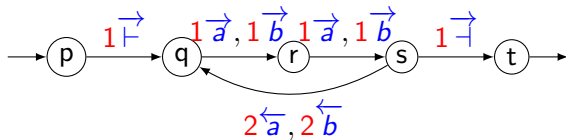

# Two-way automata are one way ! (over the tiles)

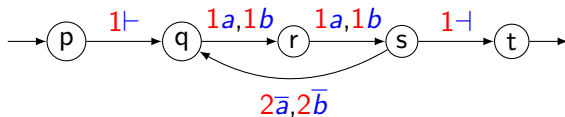
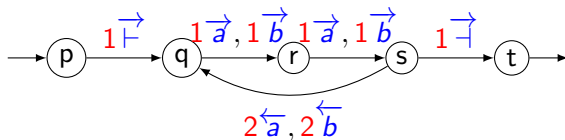

# Two-way automata are one way ! (over the tiles)

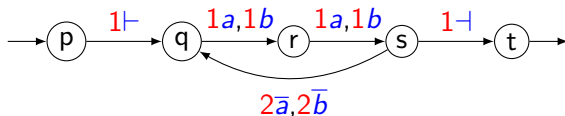
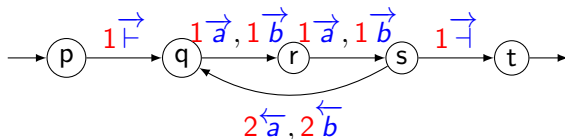

$$\vdash ((a + b)(a + b)2(\bar{a} + \bar{b}))^* (a + b)(a + b)\vdash$$

tile of the form  $\vdash u \vdash$

# Two-way automata are one way ! (over the tiles)

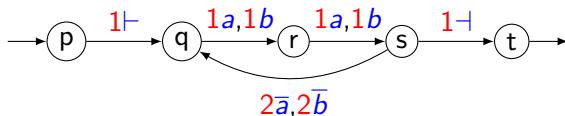
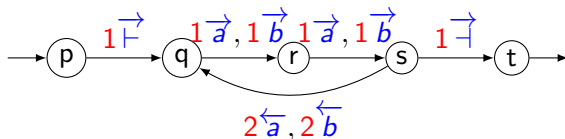

$$\vdash ((a + b)(a + b)2(\bar{a} + \bar{b}))^* (a + b)(a + b) \dashv$$

tile of the form  $\vdash u \dashv$

## Functions over transitions

$\lambda(p, k, m, q) = m$  : label

$\pi(p, k, m, q) = k$  : weight

run :  $[q, 1, a, r], [r, 1, b, s], [s, 2, \bar{b}, q], [q, 1, b, r] = w$

$\pi(w) = 1.1.2.1 = 2$     $\lambda(w) = ab\bar{b}b = ab$  the tile!

run :  $[q, 1, a, r], [r, 1, b, s], [s, 2, \bar{b}, q], [q, 1, b, r] = w$

$\pi(w) = 1.1.2.1 = 2$     $\lambda(w) = ab\bar{b}b = ab$  the tile!

$R_A$  accepting paths: language of transitions words, rational.



run :  $[q, 1, a, r], [r, 1, b, s], [s, 2, \bar{b}, q], [q, 1, b, r] = w$

$\pi(w) = 1.1.2.1 = 2$     $\lambda(w) = ab\bar{b}b = ab$  the tile!

$R_{\mathcal{A}}$  accepting paths: language of transitions words, rational.

$$[[\mathcal{A}]](t) = \sum_{w \in R_{\mathcal{A}} \cap \lambda_{\mathcal{A}}^{-1}(t)} \pi_{\mathcal{A}}(w)$$

run :  $[q, 1, a, r], [r, 1, b, s], [s, 2, \bar{b}, q], [q, 1, b, r] = w$

$\pi(w) = 1.1.2.1 = 2$     $\lambda(w) = ab\bar{b}b = ab$  the tile!

$R_{\mathcal{A}}$  accepting paths: language of transitions words, rational.

$$\llbracket \mathcal{A} \rrbracket(t) = \sum_{w \in R_{\mathcal{A}} \cap \lambda_{\mathcal{A}}^{-1}(t)} \pi_{\mathcal{A}}(w)$$

Valid ?

run :  $[q, 1, a, r], [r, 1, b, s], [s, 2, \bar{b}, q], [q, 1, b, r] = w$

$\pi(w) = 1.1.2.1 = 2$     $\lambda(w) = ab\bar{b}b = ab$  the tile!

$R_{\mathcal{A}}$  accepting paths: language of transitions words, rational.

$$[[\mathcal{A}]](t) = \sum_{w \in R_{\mathcal{A}} \cap \lambda_{\mathcal{A}}^{-1}(t)} \pi_{\mathcal{A}}(w)$$

Valid ? Over rat. add.  $\sum_{w \in L} \varphi(w)$  exists when  $L$  rational,  $\varphi$  morphism.

$$u \mapsto (\tilde{u})^*$$

$$\vdash ((a + b)^* \dashv \bar{\vdash} (\bar{a}a + \bar{b}b)^* \bar{\vdash} \vdash)^* (a + b)^* \dashv$$

$$u \mapsto (\tilde{u})^*$$

$$\vdash ((a + b)^* \dashv \bar{\vdash} (\bar{a}a + \bar{b}b)^* \bar{\vdash} \vdash)^* (a + b)^* \dashv$$

Rational expressions ! (over tiles)

$$\llbracket E.F \rrbracket(t) = \sum_{t_1 t_2 = t} \llbracket E \rrbracket(t_1) \llbracket F \rrbracket(t_2)$$

$$u \mapsto (\tilde{u})^*$$

$$\vdash ((a + b)^* \dashv \bar{\vdash} (\bar{a}a + \bar{b}b)^* \bar{\vdash} \vdash)^* (a + b)^* \dashv$$

Rational expressions ! (over tiles)

$$\llbracket E.F \rrbracket(t) = \sum_{t_1 t_2 = t} \llbracket E \rrbracket(t_1) \llbracket F \rrbracket(t_2)$$

Validity ?

$\mathbb{K}$  rationally additive,  $\mathcal{T}$  the tile monoid.

Tiles of the form  $\vdash w \dashv$

## Theorem

Two-way  $\mathbb{K}$ -automaton

$\Leftrightarrow$

$\mathbb{K}$ -automaton over  $\mathcal{T}$

$\Leftrightarrow$

$\mathbb{K}$ -expression over  $\mathcal{T}$ .

Extension of the boolean result (Dicky-Janin) to the weighed case.

# Outline

- 1 Preliminary notions
- 2 Tiles
- 3 Monoids automata and expressions**
- 4 Transformations



# Trees

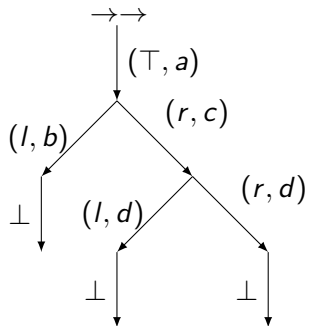
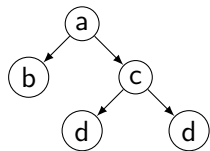

# Trees

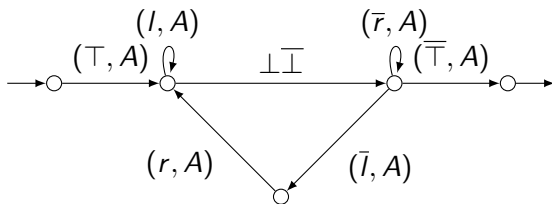
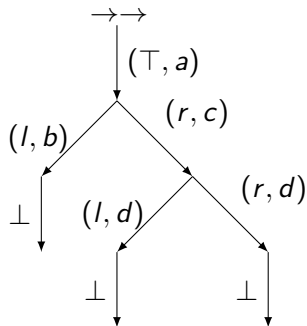
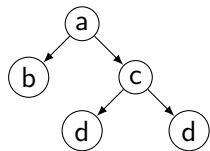

$M$

$G$      $M$

$G^*$      $M$

$$\varphi : G^* \mapsto M$$

$$\varphi : G^* \mapsto M$$

Such that  $\varphi^{-1}(m)$  is rational  $\forall m$  :

$$\varphi : G^* \mapsto M$$

Such that  $\varphi^{-1}(m)$  is rational  $\forall m$  :

with  $\pi$  morphism from  $G^*$  to  $\mathbb{K}$   $\sum_{w \in \varphi^{-1}(m)} \pi(w)$  exists !

All automata are valid.



$$\varphi : G^* \mapsto M$$

Such that  $\varphi^{-1}(m)$  is rational  $\forall m :$

with  $\pi$  morphism from  $G^*$  to  $\mathbb{K}$   $\sum_{w \in \varphi^{-1}(m)} \pi(w)$  exists !

All automata are valid.

## Example

- Free inverse monoid (Tiles, trees)
- Graded monoids.
- Idempotent generators.

Not the free group

# Outline

- 1 Preliminary notions
- 2 Tiles
- 3 Monoids automata and expressions
- 4 Transformations**

$\mathbb{K}$  rationally additive,  $M$  pre-rational monoid.

## Theorem

$\mathbb{K}$ -automaton over  $M$   $\Leftrightarrow$   $\mathbb{K}$ -expression over  $M$

$$\begin{array}{ccc} \mathcal{A}, \mathbb{K}, M & \dashrightarrow & E, \mathbb{K}, M \\ \downarrow & & \uparrow \\ \mathcal{A}, \Sigma & \longrightarrow & \text{Unamb. } E, \Sigma \end{array}$$

$$\begin{array}{ccc}
 \mathcal{A}, \mathbb{K}, M & \dashrightarrow & E, \mathbb{K}, M \\
 \downarrow & & \uparrow \\
 \mathcal{A}, \Sigma & \longrightarrow & \text{Unamb. } E, \Sigma
 \end{array}$$

$$\begin{array}{ccc}
 \mathcal{A}, \mathbb{K}, M & \dashleftarrow & E, \mathbb{K}, M \\
 \uparrow & & \downarrow \\
 \text{Unamb. } \mathcal{A}, \Sigma & \longleftarrow & \text{Unamb. } E, \Sigma
 \end{array}$$

# Automata to Expression

Automaton

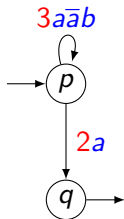

$\llbracket \mathcal{A} \rrbracket (m)$

# Automata to Expression

Automaton  $\rightarrow$  Accepting runs,  $\lambda$ ,  $\pi$ .

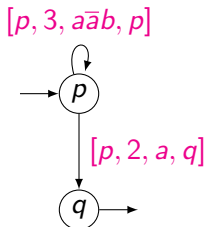
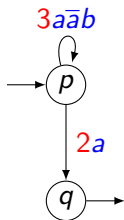

$$\llbracket \mathcal{A} \rrbracket (m) = \sum_{\substack{w \in \lambda^{-1}(m) \\ \cap R_{\mathcal{A}}}} \pi(w)$$

# Automata to Expression

Automaton  $\rightarrow$  Accepting runs,  $\lambda, \pi$ .  $\rightarrow$  Unambiguous expression

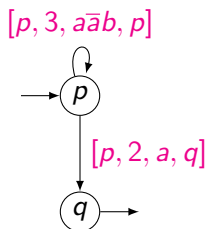
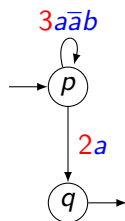

$[p, 3, a\bar{a}b, p]^* [p, 2, a, q]$

$$\llbracket \mathcal{A} \rrbracket (m) = \sum_{\substack{w \in \lambda^{-1}(m) \\ \cap R_{\mathcal{A}}}} \pi(w) = \sum_{w \in \lambda^{-1}(m)} \pi(w) \chi_E(w)$$



# Automata to Expression

Automaton  $\rightarrow$  Accepting runs,  $\lambda$ ,  $\pi$ .  $\rightarrow$  Unambiguous expression  $\rightarrow$  Substitution  $\lambda$ ,  $\pi$ .

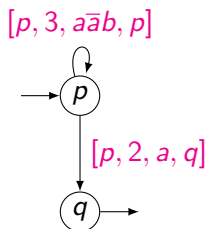
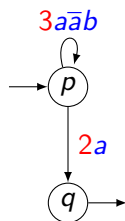

$[p, 3, a\bar{a}b, p]^* [p, 2, a, q]$   $(3a\bar{a}b)^* 2a$

$$\llbracket \mathcal{A} \rrbracket (m) = \sum_{\substack{w \in \lambda^{-1}(m) \\ \cap R_{\mathcal{A}}}} \pi(w) = \sum_{w \in \lambda^{-1}(m)} \pi(w) \chi_E(w) = \llbracket E_{\lambda\pi} \rrbracket (m)$$

From  $F$ , we want  $E$  unambiguous,  $\lambda, \pi$  such that:

$$\llbracket F \rrbracket(m) = \llbracket E_{\lambda\pi} \rrbracket(m)$$

$$F = (m^*)^*2 \quad \rightarrow \quad E = ([m, 0]^*)^*[2, 1]$$

# Expression to automata

From  $F$ , we want  $E$  unambiguous,  $\lambda, \pi$  such that:

$$\llbracket F \rrbracket(m) = \llbracket E_{\lambda\pi} \rrbracket(m)$$

$$F = (m^*)^*2 \rightarrow F' = (m^*1)^*1.2 \rightarrow E = ([m, 0]^*[1, 1])^*[1, 2][2, 3]$$

# Expression to automata

From  $F$ , we want  $E$  unambiguous,  $\lambda, \pi$  such that:

$$\llbracket F \rrbracket(m) = \llbracket E_{\lambda\pi} \rrbracket(m)$$

$$F = (m^*)^*2 \rightarrow F' = (m^*1)^*1.2 \rightarrow E = ([m, 0]^*[1, 1])^*[1, 2][2, 3]$$

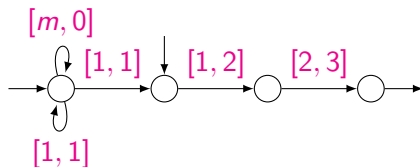

# Expression to automata

From  $F$ , we want  $E$  unambiguous,  $\lambda, \pi$  such that:

$$\llbracket F \rrbracket(m) = \llbracket E_{\lambda\pi} \rrbracket(m)$$

$$F = (m^*)^*2 \rightarrow F' = (m^*1)^*1.2 \rightarrow E = ([m, 0]^*[1, 1])^*[1, 2][2, 3]$$

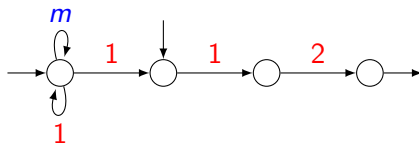

Extension of weighted Kleene theorem to other monoids.

Extension of weighted Kleene theorem to other monoids.

Rational expressions for two-way!

Extension of weighted Kleene theorem to other monoids.

Rational expressions    for two-way!  
                                  for tree walking!



Extension of weighted Kleene theorem to other monoids.

Rational expressions    for two-way!  
                                  for tree walking!  
                                  for graphs?

# Conclusion

Extension of weighted Kleene theorem to other monoids.

Rational expressions    for two-way!  
                                  for tree walking!  
                                  for graphs?

Trade-off between  $\mathbb{K}$  and  $M$

# Conclusion

Extension of weighted Kleene theorem to other monoids.

Rational expressions    for two-way!  
                                  for tree walking!  
                                  for graphs?

Trade-off between  $\mathbb{K}$  and  $M$

Easy construction, tedious proof

# Conclusion

Extension of weighted Kleene theorem to other monoids.

Rational expressions    for two-way!  
                                  for tree walking!  
                                  for graphs?

Trade-off between  $\mathbb{K}$  and  $M$   
Easy construction, tedious proof

Thank you for your attention.

# Automates

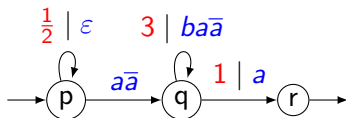

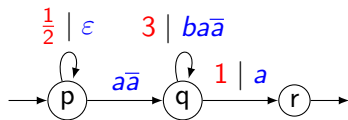
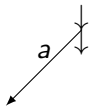

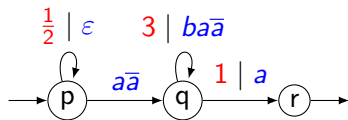
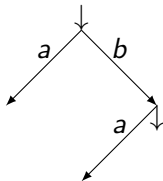

# Automates

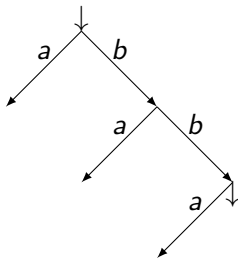
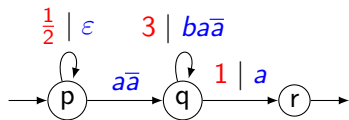



# Automates

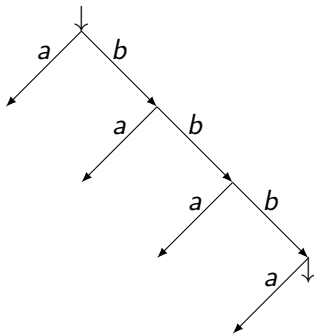
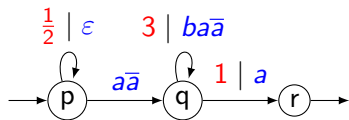

# Automates

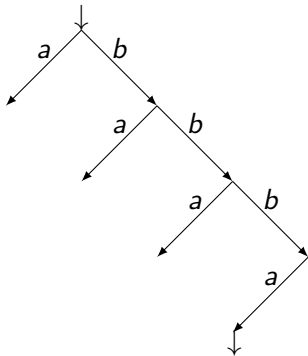
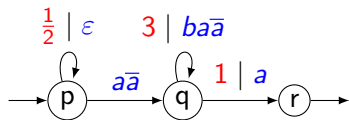

# Monoïde inversif libre

$$\bar{A} = \{\bar{a} \mid a \in A\}.$$

$\bar{\cdot}$  de  $(A \cup \bar{A})^*$  vers  $(A \cup \bar{A})^*$  inductively as:

$$\bar{\varepsilon} = \varepsilon \quad \overline{u\bar{a}} = \bar{a}\bar{u} \quad \overline{\bar{a}} = a\bar{u}.$$

## Monoïde inversif libre

Quotient de  $(A \cup \bar{A})^*$  par

$$x\bar{x}x = x \quad \bar{x}x\bar{x} = \bar{x} \quad x\bar{x}y\bar{y} = y\bar{y}x\bar{x}$$

# Et si ça ne matche pas ?

Arbres de Munn.

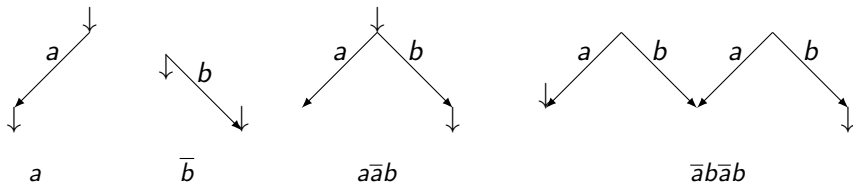

# Le lemme qui fait tout marcher.

$E$  NA booléenne,  $\mathbb{K}$  rat. add.,  $M$  (pas nécessairement pré-rat).  $\lambda, \pi$  morphismes.

## Lemme

$E_{\lambda, \pi} = E[\forall a, a \leftarrow \lambda(a)\pi(a)]$  valide

$\Leftrightarrow$

$m \in M$ ,  $F$  sous-expression de  $E$ :

$\sum_{\lambda(w)=m} \pi(w)\chi_F(w)$  existe.

# Le lemme qui fait tout marcher.

$E$  NA booléenne,  $\mathbb{K}$  rat. add.,  $M$  (pas nécessairement pré-rat).  $\lambda, \pi$  morphismes.

## Lemme

$E_{\lambda, \pi} = E[\forall a, a \leftarrow \lambda(a)\pi(a)]$  valide

$\Leftrightarrow$

$m \in M$ ,  $F$  sous-expression de  $E$ :

$\sum_{\lambda(w)=m} \pi(w)\chi_F(w)$  existe.

$$\llbracket E_{\lambda, \pi} \rrbracket(m) = \sum_{\lambda(w)=m} \pi(w)\chi_E(w)$$

# Expression vers automate : exemple

$$a + a + 2b^* \rightarrow [a, 0] + [a, 1] + [2, 2][b, 3]^*[1, 4]$$

# Expression vers automate : exemple

$$a + a + 2b^* \rightarrow [a, 0] + [a, 1] + [2, 2][b, 3]^*[1, 4]$$

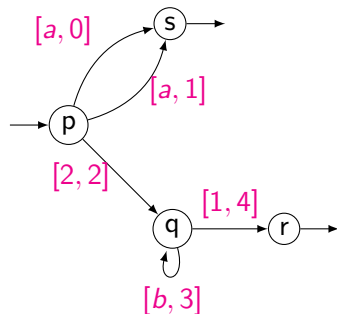



# Expression vers automate : exemple

$$a + a + 2b^* \rightarrow [a, 0] + [a, 1] + [2, 2][b, 3]^*[1, 4]$$

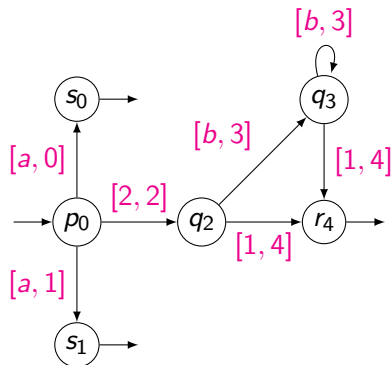
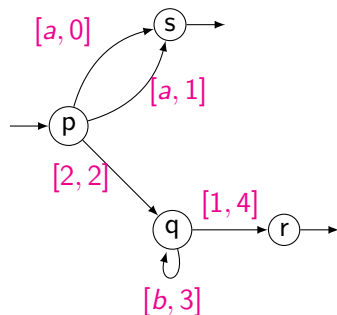

# Expression vers automate : exemple

$$a + a + 2b^* \quad \rightarrow \quad [a, 0] + [a, 1] + [2, 2][b, 3]^*[1, 4]$$

